



Solenoids

Electronic Drives

Ledex® Coil Suppressors

A voltage is generated by a changing magnetic field in proximity to a current-carrying member. The equation $E = -N \frac{d\phi}{dt}$, describes this by saying that the magnitude of the voltage is proportional to the number of turns (N), i.e., of a coil, and the rate of change of a magnetic field. This theory can be easily demonstrated by hooking a coil of wire to a voltmeter and passing a magnet through it. It can be observed that the faster the magnet moves, the higher the voltage. Essentially, the same theory applies when making a generator.

Reading the equation the other way suggests that if a voltage is applied to a coil of wire, a change in the magnetic field will occur; i.e., before the voltage is applied, no field exists. Applying a voltage will cause a field to be generated, which will be maintained as long as the voltage is applied. When the voltage is removed, the field must dissipate.

Nearly everyone is familiar with spark plugs in gasoline engines. A spark is generated due to a voltage between the contacts which is higher than the dielectric strength of air (which has a dielectric strength of approximately 40 volts/mil). If a spark plug is gapped at 0.025", a voltage of $25 \times 40 = 1,000$ volts would be necessary to create a dielectric breakdown (spark).

How is more than 1,000 volts generated from a 12-volt automobile battery? A coil is charged with 12 volts, and when that voltage is removed, a voltage is created which is dissipated across the gap of the spark plug.

This is similar to the operation of a solenoid, except the voltage generated is not useful in a typical solenoid circuit. In most cases, voltages of that great a magnitude would be damaging if not correctly suppressed. Damage can appear as a transfer of material, to welding of hard contacts, to destruction of the switching transistors junction, to even causing a dielectric breakdown of the coil insulation.

Ledex coil suppressors minimize contact arcing and suppress the reverse voltage transient to safe levels to protect semiconductor switches. Coil suppressors should be used with all DC solenoid and relay coils to protect associated circuitry and to aid in minimizing electromagnetic interference (emi).

Note in Figure 1 that switching on the AC side of the rectifier also slows the drop-out time of a solenoid which is advantageous for improved life of the solenoid. If drop-out time is critical, the solenoid must be switched on the DC side and a high-speed coil suppressor should be connected across the solenoid coil.

Refer to Figure 2, which shows a typical coil suppressor connection noting the polarities of the power source and suppressor.

Coil suppressors are designed for operation from -55°C to 80°C, with special models designed for 125°C incorporating JAN-rated electronic components.



Figure 1. Switching on AC Side

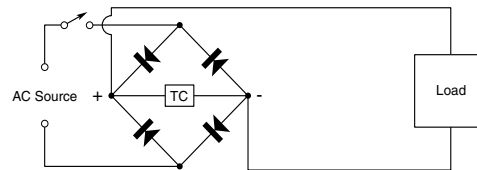
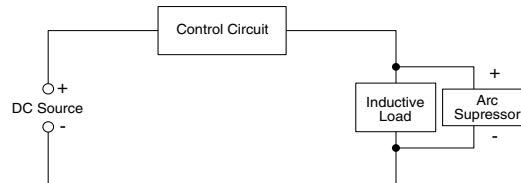

Figure 2. Coil Suppressor Connection



Oscilloscope trace depicting coil suppression



LEFT: Typical trace with capacitor as coil suppressor when 28 volt pulse to inductive load is interrupted. Collapsing magnetic field can generate a spike in excess of 550 volts. Spikes can short capacitors, cause coil burnout or damage other circuit components.

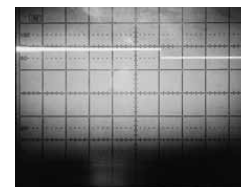

RIGHT: Same inductive load interrupted under identical conditions but with coil suppressor No. 122654-001 connected in parallel with coil. Results:
• Eliminate arcing
• Extended contact life
• Minimize transients
• Protects other circuit components



Solenoids

Electronic Drives

Ledex® Coil Suppressors

Diode/Capacitor Design

Use Type A diode/capacitor designs when the lowest peak reverse voltage is required and when highest operating speed is not necessary.

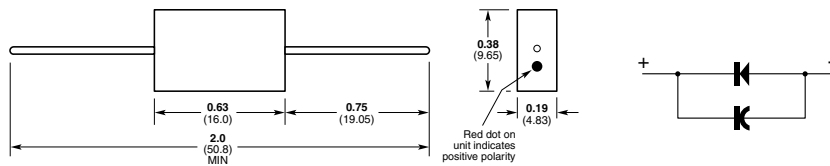

Type A

Part Number 122654-001 (not RoHS Compliant)
Part Number 122655-001 (not RoHS Compliant)

Diode/Capacitor/Zener Design

Use these models when highest operating speed is required and when lowest peak reverse voltage rating is not necessary.

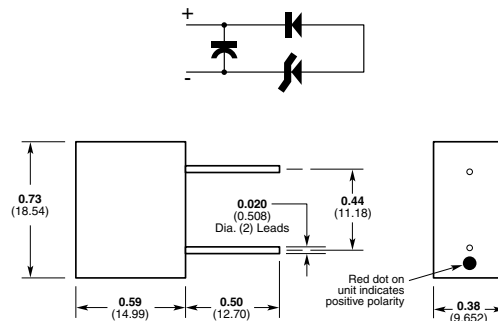

Type C

Part Number 190805-001
Part Number 190810-001

Coil Suppressor Type (not RoHS Compliant)	Maximum Operating Voltage (VDC)	PIV Peak Inverse Voltage (VDC)	Use with Ledex Solenoids (Size)	Diode Capacitor Type	Part Number
Diode/Capacitor	33	1	1-8	A	122654-001
Diode/Capacitor	200	1	1-6 *	A	122655-001
Diode/Capacitor/Zener	33	10	1-8	C	190805-001
Diode/Capacitor/Zener	200	36	1-6 *	C	190810-001

* Suppression of arcing on hard switch contacts can be supplemented by placing a 0.05 mfd, 200 volt (min.) capacitor across the contacts in addition to our coil suppressor across the load.



Solenoids

Electronic Drives

Ledex® Rectifiers

Ledex® Rectifiers whose DC terminals are connected to the solenoid coil are self suppressing when switched on the AC side of the rectifier. In addition, Ledex rectifiers employ AC line transient suppressors to protect from incoming voltage spikes. Hard contact switches can be supplemented by adding a 0.05 to 0.1 mfd, 200 volt (min.) capacitor across the contacts to further minimize contact arcing.

Efficient, light, and exceptionally reliable, Ledex transient protected silicon bridge rectifiers have built-in transient control. High voltage spikes on either AC or DC sides are automatically clipped at 200 volts, protecting the diode cells as well as other circuit components.

Our silicon bridge rectifiers are carefully constructed and sealed to meet general requirements of military specification MIL-E-5400 on insulation, terminals, vibration, shock, sand and dust, fungus, and salt atmosphere.

They are recommended for use with all our electromechanical products, as well as for other systems which may be subjected to high voltage spikes from solenoids, relays and other inductive equipment sharing a common AC line. Storage and ambient temperature range is -55°C to 120°C.

Transient Protection

One of the early problems associated with the introduction of semiconductors was the destruction of diode cells and other circuit components by transients generated from collapsing magnetic fields.

A transient spike in the high resistance direction and beyond the diode PIV rating destroys the diode. In a silicon bridge, destruction can occur from transients generated by the inductive load or from other points on the AC system.

Low Resistance.
High Current Capacity.
Low Voltage Drop

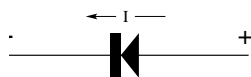

High Resistance.
Leakage Current Only. High
Voltage Drop (Limited by PIV)

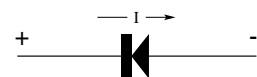

To prevent current flow in the inverse direction, our silicon rectifiers have a low resistance shunt control built across the DC terminals. It allows the energy of the transient from the AC side to be dissipated through the forward direction of the diodes, protecting the rectifier as well as other circuit components. Transients from the DC side are dissipated directly through the built-in control device.

When there is only a minor possibility of transients from the AC side of a silicon rectifier, the need for transient protection may be eliminated by placing the control switch on the AC side. In this way the rectifier is closed only when the load is energized, and the

Consideration should be given to the slower operating speed that results when an inductive load is switched from the AC side.

Oscilloscope Trace of Transient Protection

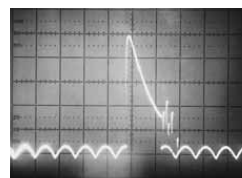

LEFT: Actual wave form read from DC output of unprotected full wave silicon bridge rectifier powering an inductive load. To prevent cell destruction, 1500 PIV (IN-1150) diodes were used. Typical DC output of bridge appears between 0 and 165 volts.

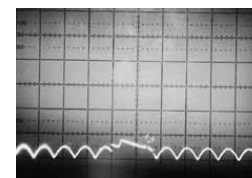

RIGHT: When transient protection circuitry is added to the DC output, the 1400 volt transients are leveled to a safe 250. (These tests were conducted with a Tektronix 555 oscilloscope with 10-to-1 attenuated probe.)

Transient from AC Line

Transients from the AC line flow through forward direction of two diodes and transient control. Forward direction can withstand the flow. Without protection, flow would be through inverse direction, resulting in diode damage.

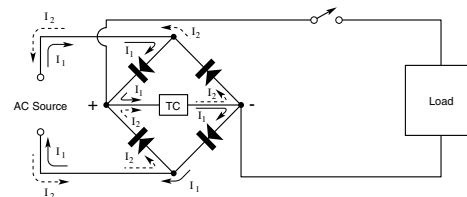

Transient from DC Load

Transients from the DC load bypass diodes by going through transient control. If transient control is removed, current path is through inverse direction of diodes.

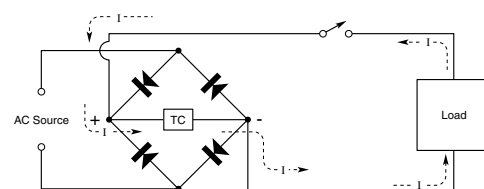



Solenoids

Electronic Drives

Ledex[®] Rectifiers

Octal Plug-In

Part Number A-46502-003 (not RoHS Compliant)

Weight: 1 5/8 oz (46 grams)

Mates with standard octal tube socket such as Cinch-Jones 8AB or equal.

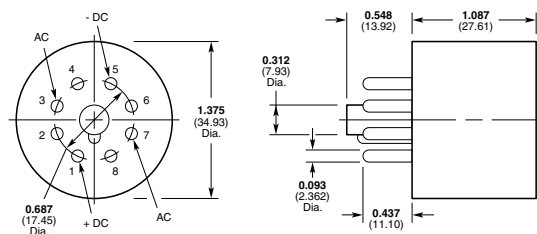

Viewed from base; locate from key

Part number 174488-001 is identical to A-46502-005 except that it has no built-in transient protection. If used with an inductive load, switching should be done on the AC side only. To switch on the DC side would require some provision to suppress transients within the 400 PIV rating. This model may also be used for applications requiring 220 VAC.

Typical Rectifier Hook-up

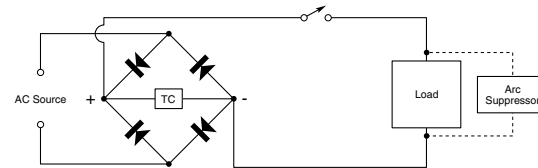

TC = Transient Control (Built-In)

Input (50-400 Hz)		Output
VRMS	Surge (amps)	(VDC)
24	25 for 1 cycle	20
115	25 for 1 cycle	100
140	25 for 1 cycle	124

Current Rating by Duty Cycle

Duty Cycle %	20° to 75°C		100°C	
	Max Current (Amps)	Max Pulse Length (Sec)	Max Current (Amps)	Max Pulse Length (Sec)
100	1.8	Cont.	0.75	Cont.
75	2.4	115	1.0	115
50	3.6	100	1.5	100
25	7.2	43	3.0	43
10	7.5	20	4.0	20

Maximum Ratings (25°C Ambient)

Rating	Value
RMS applied voltage	139 VRMS
Recurrent peak voltage	184 volts
DC applied voltage	175 volts
Average rectified forward current at 60 Hz	1.8 amp
Non-repetitive peak surge current for 1 cycle	30 amp
Average transient energy dissipation	20 joules
Peak transient current on DC side of bridge (current spike $t_p < 20 \mu\text{sec}$)	1,000 amps
Operating temperature	-55°C to 115°C

Electrical Characteristics

Characteristic	Typical	Max
Forward voltage drop ($I_F = 1.0 \text{ amp}$, $T_c = 25^\circ\text{C}$)	1.8	2.2 volts
Transient voltage clipping level		273 volts

NOTE: The output of the rectifier should not be grounded unless the input is isolated from the power line by a transformer.



Solenoids

Electronic Drives

Ledex® Hold-In Circuit Modules

These convenient modules provide solutions to applications requiring high starting torque but lower holding torque at the end of the stroke. The modules supply high power to the solenoid to move your load, then reduce the wattage to a lower power level to hold the solenoid in the energized position. These modules use pulse width modulation to reduce the effective voltage to the solenoid to a preselected lower value.

DC Hold-In Module for PWM Operation (Pick and Hold)

Part Number 152160-001 (not RoHS Compliant)

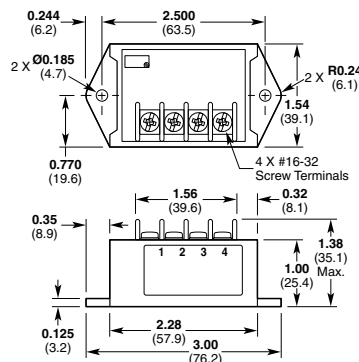

- Delivers full power for 50 milliseconds ($\pm 20\%$), then reduces voltage to a user-selected range of 10% to 75% full voltage input (approximately 10% factory setting.)
- Operating voltage is 12 - 24 VDC input
- Black ABS plastic housing with terminal strip connections
- Operating temperature is 0°C to 50°C
- Suitable for use on Ledex size 5 solenoids or smaller
- Potentiometer adjustment of hold-in voltage/current
- Not RoHS compliant

Input Voltage Range:	11-26 VDC
Maximum Holding Current:	1.0 amps
Maximum Pull-In Current:	8.0 amps
Minimum Load Resistance:	3.3 ohms @26 VDC input
Holding Current (approximate):	$V_{in} \times \text{duty cycle} / \text{coil resistance}$
Maximum Repetition Rate:	Once every second

Operation: The hold-in module is connected permanently to the solenoid leads. Upon application of DC power to the input terminals, full power is delivered to the solenoid for 50 ms. Power is then reduced automatically to a user-selected value (10 to 75% of full input voltage). This reduced hold-in voltage is maintained until the input voltage to the module is turned off. This action removes power to the solenoid and enables the module for a new cycle of full power and automatic reduction (pick and hold).

AC Hold-In Circuit Module for PWM Operation (Pick and Hold)

Part Number 187478-001 (not RoHS Compliant)

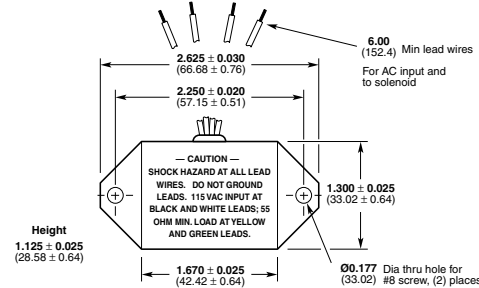

- Built-in full wave rectifier
- AC line transient protection
- Delivers full power to solenoid for 125 milliseconds, then reduces voltage to 55%
- Built-in solenoid coil suppression

Rating	Min	Typical	Max	Unit
Input voltage	95	115	135	Volts AC
Energizing pulse width	85	125	175	Millisec
Load resistance	30			Ohms
Holding current*		0.9E-2.5		Amps
		2.86R		
Operating temperature	0		+71	°C

* The holding current following the initial energizing pulse is computed by the above equation where E is the supply voltage (AC) and R is the solenoid resistance.

Operation: The hold-in circuit is connected permanently to the solenoid by means of the yellow and green lead wires. Upon application of AC power to the black and white lead wires, full power is applied to the solenoid for approximately 125 ms. The power then automatically drops to provide holding current until the AC power is removed.