

Nanomotion

Technical Design Guide





Table of Contents

Quick Reference Guide	3
Introduction	4
Core Mechanical Design: Managing Normal Force	4
Linear & Rotary Designs	4-10
Mounting Tolerances	11
Motor Sizing	11-14
Mechanical Assembly Procedures and Safeguards	15
Electrical Interface	16
Servo Tuning	17
General Operation & Safe Guards	18

Quick Reference Getting Started

- Verify proper stage mechanics with preloaded bearings and appropriate stiffness.
- Follow Nanomotion's motor mounting guidelines for preloading and motor orientation with respect to travel & verify that ceramic strip has two drops of epoxy
- Connect the ground wire from the motor to the amplifier.
- Verify the connection (jumper) between power supply return and the controller's analog ground.
- Condition the motor before tuning, per Motor Installation Manual (Always recondition the motor each time it is disengaged from the ceramic strip).
- After conditioning, wipe the ceramic with a clean cloth and IP alcohol without disengaging the motor
- Use "Abort on Position Error" (or other safety mechanism) and appropriate torque limit during initial integration and conditioning. Do not exceed 5v and 50% duty cycle.
- Avoid prolonged operation in an unstable condition (excessive vibration) during tuning process.
- Consult with Nanomotion with any questions during the set up process.

- Do not operate the motor in an un-loaded (un-mounted) condition.
- Do not exceed the duty cycle limits when operating the motor (see Motor Installation Manual).
- Do not allow the motor tips to leave contact with the ceramic strip during operation. (Use mechanical hard stops)
- Do not remove the cover of the motor (High Voltage Inside).
- Do not immerse the motor in any liquids.



Technical Guidelines for Using Nanomotion Motors

Introduction

Nanomotion motors provide direct drive performance for linear or rotary motion. Motion is transmitted through the contact of a ceramic finger pushing on a ceramic strip. The ‘friction pair’ is specifically selected to yield optimum performance with minimal wear, currently achieving 40,000 hours of operation and working in environments up to Class 10 clean rooms.

To yield the maximum performance benefits of Nanomotion’s ceramic servo motors, it is important to understand the operating characteristics of the piezo ceramic elements and the impact that it has on the mechanical structure.

As a direct drive, the Nanomotion motor is sized by the basic principles of $F=MA$ (plus the resistance of the bearing structure & the force of gravity if on an incline or vertical). While this is a basic sizing method, one must recognize that the normal force of Nanomotion’s motor directly affects the starting force based on the coefficient friction of the bearing. Additionally, bearing stiffness may be impacted by the motor preload if the bearing preload is not sufficient. Good design practice requires that a proper bearing configuration and bearing preload be established for use with Nanomotion motors.

Core Mechanical Design: Managing Normal Force

Nanomotion motors apply a normal force, into the bearing structure that is five times greater than the driving force. Simply, an HR1, which provides 1 lb. thrust, will create 5 lbs force into the bearing structure, perpendicular to motion. In addition to the normal force, there is the potential for higher acceleration forces that are placed in the same direction, impacting the bearing. Acceleration forces can easily be 2 to 3 times greater than the normal force. So, an HR1 motor, which provides 1 lb driving thrust has 5 lbs normal force and potentially 15 lbs acceleration force.

The forces applied by Nanomotion’s motor require that the bearing structure (linear or rotary) have sufficient stiffness (and preload) to support the motor force. Insufficient stiffness could result in vibration transmitted to the mechanical structure, audible noise, excessive wear, and motor burning.

Linear Bearing

To best manage the normal and acceleration forces of the Nanomotion motor, it is appropriate to have a linear bearing stiffness of 50N/ μ m. This is easily achievable with conventional bearings that are readily available on the market. From a linear bearing perspective we will consider crossed roller bearings and linear recirculating guides. But, it is perfectly appropriate to consider air bearings and other mechanical bearings that provide the appropriate stiffness.

The most common linear bearings used in precision motion are crossed rollers and linear recirculating guides. While ball bushings and air bearings are acceptable technologies, they are in the minority for precision motion.

For purposes of this document we will define several types of non-recirculating and recirculating linear bearings. For the scope of this document, we will expect that motor mounting on a non-recirculating bearing has the motor mounted along with the stationary base and the slide plate moves on its own. (The motor is not moving with the slide plate.)

Non Recirculating Linear Bearings

There are 3 typical configurations of non-recirculating linear bearings shown in Figure 1

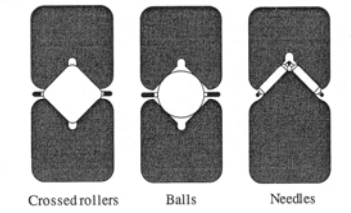
<ul style="list-style-type: none"> • Crossed Rollers (left) • Steel V-way with ball (center) • Needle Roller (Right) 	<p>Figure 1</p>  <p style="text-align: center;">Crossed rollers Balls Needles</p>
---	---

Within the scope of these bearings, “needle rollers” represent the highest stiffness, but crossed roller bearings are the most common. Crossed roller bearing sets or slides typically have a mechanical preload that allows the user to establish a preload or use factory defaults (removing all play in the bearing) and exercise the stiffness of the bearing.

Crossed rollers are very stiff, typically measuring $\sim 45\text{N}/\mu\text{m}$, per roller (based on a 6mm diameter), with half the rollers carrying the load. This is perfectly sufficient for Nanomotion motors, however the bearing preload must be independent of the motor preload, meaning do not use the motor itself to create the preload on the bearing.

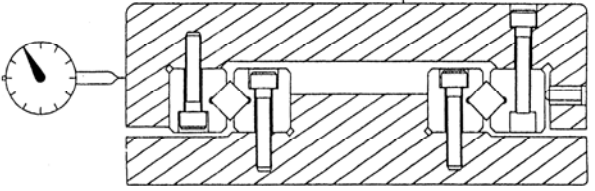
<p>Non-recirculating bearings have a slide plate that moves and a roller strip that moves half the distance of the slide plate. In these instances, it is most appropriate to have the motor mounted on the centerline of the bearing structure, both vertically and horizontally.</p> <p>Vertically, it is most desirable to be in the plane of the bearing, near where the indicator is shown on figure 2.</p>	<p>Figure 2</p> 
--	--

Horizontally, it is important to be as close to center linearly. The primary objective is to have the motor mounted on the center of the length of the slide. Shown in Figure 3.

Off center mounting will contribute to Yaw error and potentially contribute to roller migration. Mounting on center assures that the motor force will not disturb the bearing.

Even with a center mounting, with ultra precision motion systems, the yaw error should be calculated and factored in, as it will impact positioning accuracy.

Figure 3

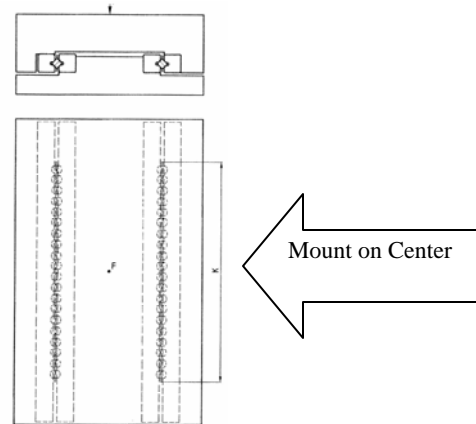

Recirculating Linear Bearings

Linear recirculating bearings represent much greater variability, as there are many types of recirculating guides and preload levels. This results in different bearing stiffnesses in different load directions.

The initial distinction that is made relates to the contact pattern of a recirculating guide. The primary distinction is a two point or four point contact pattern, with the four point contact referred to as a Gothic Arc.

The basic difference between 2 point contact and 4 point contact is that 2 point contact touches the ball on the rolling axis, where 4 point contact has 4 points touching on non rolling axes and induces much more friction into the system.

While 2 point contact (on left) touches on its rolling diameter, it limits the amount of load capacity/stiffness in directions other than pure dynamic load, but maintains lower rolling friction.

The 4 point configuration (on right) offers much more loading in moment load capacity, but in turn, has much higher static friction, resulting in more break away force required from the motor.

Recirculating Bearing Contact Patterns

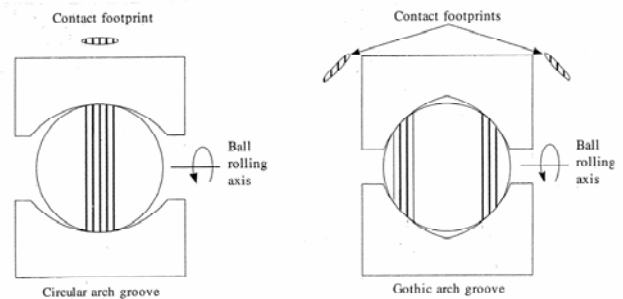

In addition to the bearing configuration, the bearing preload is very important as it relates to stiffness.

Each recirculating puck can travel up and down the length of a given rail. It is important that each individual puck has a preload. The preload is created by 'sizing' the ball bearings to be larger than the clearance allows, ultimately establishing compression on the balls.

As typical configurations use either 2 pucks with a single rail or two parallel rails, with 4 pucks, having a preload on the bearings is essential.

Recirculating Linear Guides (with balls or rollers)

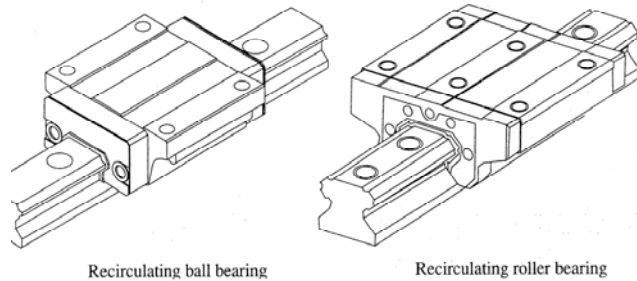

Recirculating bearings are typically used for longer travel applications, greater than 150mm, and thus are configured where the motor travels with the slide, always maintaining central contact on the bearing.

Attention must also be paid to the recirculating bearing style, as some bearings are better suited to downward loads, while others are suited to equal loads in all directions. Bearings that are suited to downward loads have minimal side load capacity. This coupled with a light preload could result in low stiffness, mechanical noise and potential wear.

For reference:

THK SSR 15 series is designed primarily for downward load, with some capacity in side direction and poor capacity in the upward direction.

THK SHS 15 series is designed for equal loading in all directions

Bearing Type	Preload	Stiffness
SSR15	C1	20N/μm
SSR15	C0	70N/μm
RSR9K	C1	20N/μm
RSR9Z	C1	10N/μm

Please note that while these numbers may not appear in the published catalogs, they are supplied by the engineering staff of the linear guide manufacturers.

Rotary Bearings

Rotary applications with Nanomotion motors are quite common as the direct drive motor can eliminate worm gears, belts and other rotary transmissions. In rotary applications there is design flexibility to apply the motor axially, driving on the flat surface of a disk, or radially, driving on the circumference of a ring.

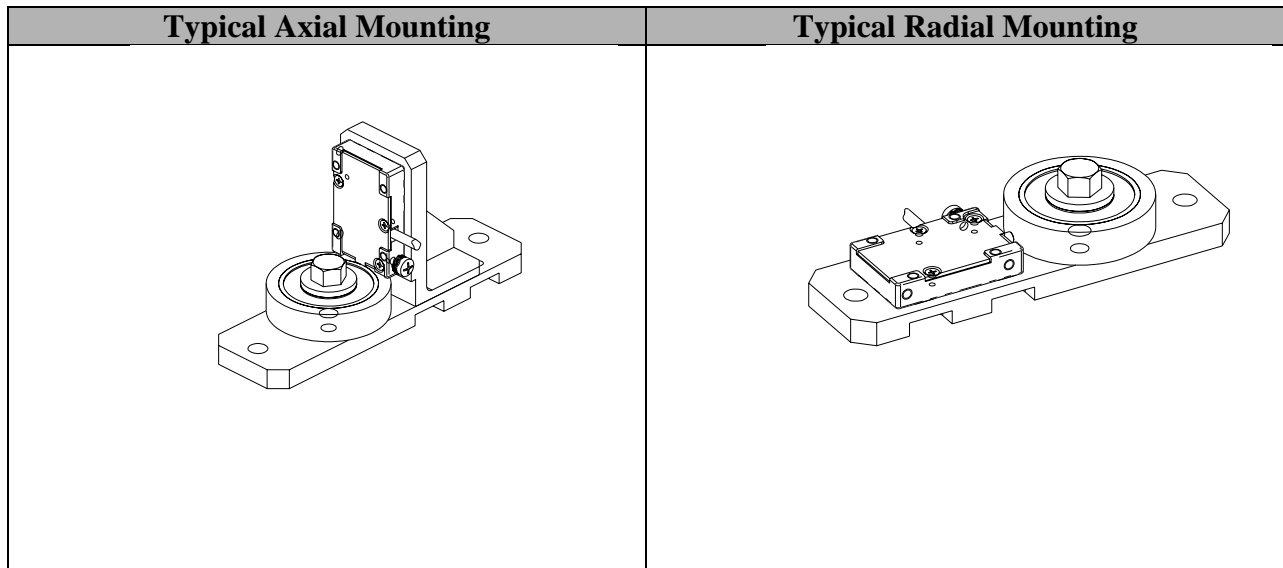

As with linear bearings, the bearing stiffness is critical to the performance of the Nanomotion motor. Moreover, a single motor applied axially will induce a moment load on the bearing whereas a single motor applied radially will induce a side load on the bearing structure. In many rotary applications it is appropriate to consider the use of two smaller motors, mounted 180° apart to maintain a balanced load on the bearing. Mounting two motors that are not 180° apart, with a slightly different angle, can also help to maintain a preload on the bearing and have a positive impact.

In evaluating rotary bearings, there are 3 common types that are utilized in rotary stages:

Rotary crossed roller

Angular contact

Deep groove radial

While the same stiffness criteria apply to rotary applications, 50N/μm, each bearing offers different operating characteristics.

Rotary crossed roller

A crossed roller bearing consists of a series of rollers with alternating axes, applied between circular machined V ways. This bearing style is very low profile and provides very high stiffness. However, as the roller bearings are not tapered, larger diameter rollers have much higher friction coefficients, based on the contact pattern.

The crossed roller bearing will offer the lowest profile and the ability to work with a single bearing. The bearing can provide sufficient stiffness in a single row, and be utilized in an axial or radial manner.

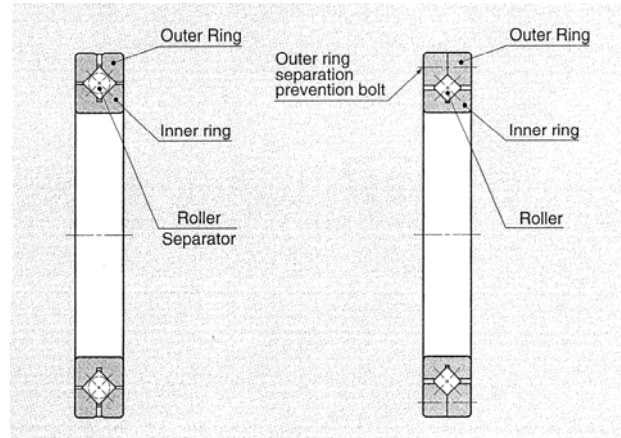

Angular contact

Angular contact bearings come in a variety of configurations. There are angles that are designed to provide higher axial load with good radial stiffness and there are contact angles that provide higher radial stiffness with good axial support. Typically the contact angles can range from 14° to 40°, so it is very important to understand the design of the specific bearing.

The primary advantage of angular contact bearings is that the contact angle is a two point contact that can support higher preloads, without increasing friction. These bearings can provide both precision and load carrying levels in an effective package.

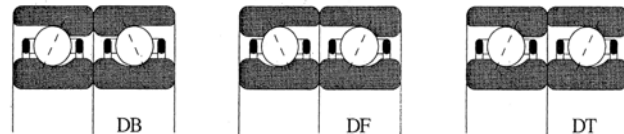

Angular contacts are typically provided in match-ground sets. These sets are provided for a variety of mounting configurations (front-to-front, back-to-back), each yielding different stiffness levels in different directions.

Caution must be used in setting up these bearings to avoid mis-applying. If the bearing is reversed from the intended mounting, the load capacity and stiffness will be greatly reduced.

DB and DF will provide the axial capacity of one bearing with high radial stiffness. DT will provide double the axial stiffness when applied in the correct orientation, and no stiffness in the reverse direction.

Deep groove radial

Deep groove bearings are acceptable, so long as the stiffness level meets the criteria for use with Nanomotion motors. These bearings utilize ball bearings captured inside a deep groove. They provide low friction and need to be applied in pairs and preloaded. While designed optimally for radial loads, this bearing configuration will be physically the largest, to provide optimum stiffness.

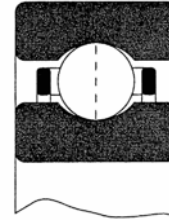

Deep groove

Based on the contact angle and the rolling axis, it is most appropriate to use this bearing design when operating radially. Use of this bearing for axial motor mounting will require a large bearing size and is best when multiple motors are spaced around the disk for uniform loading.



Mechanical Mounting Tolerance

The Nanomotion motor is constructed with a spring behind each motor element. This spring is designed to provide a preload (normal force) as well as allow for mounting inaccuracies. The spring can compensate for 'out of parallel' conditions up to 50 μ m (.002").

All of the bearing types discussed provide linear accuracies well within these tolerances, but the machined mounting surfaces will contribute to linear accuracy. It should, however, be achievable to control linear straightness to 50 μ m in a precision motion system.

For systems that require ultrahigh resolution (below 100nm) and smooth constant velocity, it is important to maintain tighter tolerances on the straightness of motion, to optimize the servo performance.

Motor Sizing

Each HR series motor element provides 4.4N (1 lbs) of dynamic stall force. The static holding per element is 75% of the dynamic stall force, so an HR1 motor providing 4.4N of dynamic stall force, provides 3.5N of static holding.

Based on using low friction bearings (<.007 Cof), a direct drive motor is sized by using $F=MA$. In addition to the mass, it is necessary to factor in the starting frictional force based on the coefficient of friction and any inclination of the axis.

While it is certainly possible to move large masses with small motors, acceleration and move profile become limited. Using a motor horizontally the following sizing formulas should be evaluated:

In sizing a permanent magnet brushless dc motor, acceleration of a load is the primary factor of consideration as the motor will require the most amount of current during this time. The acceleration force requirement is directly related to the motor's peak force capability and current limitations.

In sizing a Nanomotion motor, the primary factor is where will the work be done, in terms of speed and force. Identifying the force required at the maximum velocity will ultimately determine which motor(s) can support the application. As ceramic servo motors do not pull peak current during acceleration like a dc motor, it is based on the required speed and force to point to achieve the profile.

Below are basic equations (in word format) to understand the sizing process.

In the equation $F = MA$
Peak Force = Total Mass * Rate of Acceleration

The moving mass, however must include all the associated load, such as:

- Customer weight
- Slide weight
- Bearing drag & Cof
- Cable drag

Known Information from a Customer

- Customer weight to move
- Move distance (for typical move & total travel)
- Time to make move (which we break down into accel time, run time, decel time)
- Cof of bearing structure
- Thrust force if any (mounting orientation)

The Motion Analysis consists of the following:

$$\begin{array}{l} \text{Max Speed} \\ \text{(mm/sec)} \end{array} = \frac{\text{Distance Traveled}}{\text{Run Time} + (\text{Accel Time}/2 + \text{Decel Time}/2)}$$

$$\begin{array}{l} \text{Max Accel (Decel)} \\ \text{(mm/sec}^2\text{)} \end{array} = \frac{\text{Max Speed}}{\text{Accel (Decel) Time}}$$

$$\begin{array}{l} \text{Distance Traveled} \\ \text{During Accel (Decel)} \\ \text{(mm)} \end{array} = \text{Max Speed} * \frac{\text{Accel (Decel) Time}}{2}$$

$$\begin{array}{l} \text{Distance Traveled} \\ \text{During Con Velocity} \\ \text{(mm)} \end{array} = \text{Max Speed} * \text{Run Time}$$

$$\begin{array}{l} \text{Move Time} \\ \text{(Sec)} \end{array} = \text{Accel Time} + \text{Run Time} + \text{Decel Time}$$

$$\begin{array}{l} \text{Cycle Time} \\ \text{(Sec)} \end{array} = \text{Move Time} + \text{Dwell Time}$$

$$\begin{array}{l} \text{Duty Cycle} \\ \text{(\%)} \end{array} = \frac{\text{Move Time}}{\text{Cycle Time}} * 100$$

The Force Analysis Consists of the Following:

$$\text{Acceleration (Decel) Force (N)} = \text{Moving Weight} * \text{Max Acceleration (Decel) (m/sec}^2\text{)}$$

REVIEW NANOMOTION SIZING TOOL

Sizing Example:

Requirements:

Total moving mass (moving part of stage plus payload), $M = 1\text{Kg}$

Travel, $X = 0.01\text{ m}$ (horizontal orientation)

Total move time, $T = 0.1\text{ sec}$ (not including settling time)

Motion profile: trapezoidal, accelerate for 1/3 of the total time, move at constant velocity for 1/3 of the total time, decelerate for 1/3 of the total time

Calculate:

Acceleration / deceleration, $A = 4.5 * X / T^2 = 1 * 0.01 / 0.1^2 = 4.5\text{ m/sec}^2$

Maximum velocity, $V = 1.5 * X / T = 1.5 * 0.01 / 0.1 = 0.15\text{ m/sec}$

Acceleration force, $F_a = M * A = 1 * 4.5 = 4.5\text{ N}$

Add additional forces (bearing friction, load force, gravity/inclination, etc.) to obtain total force F_t . Let's neglect in this example.

Plot the point $\{F_t, V\}$ on the Force/Velocity curves. See figure below.

Select the motor whose curve is **above** the $\{F_t, V\}$ point. In this case it would be an HR4.

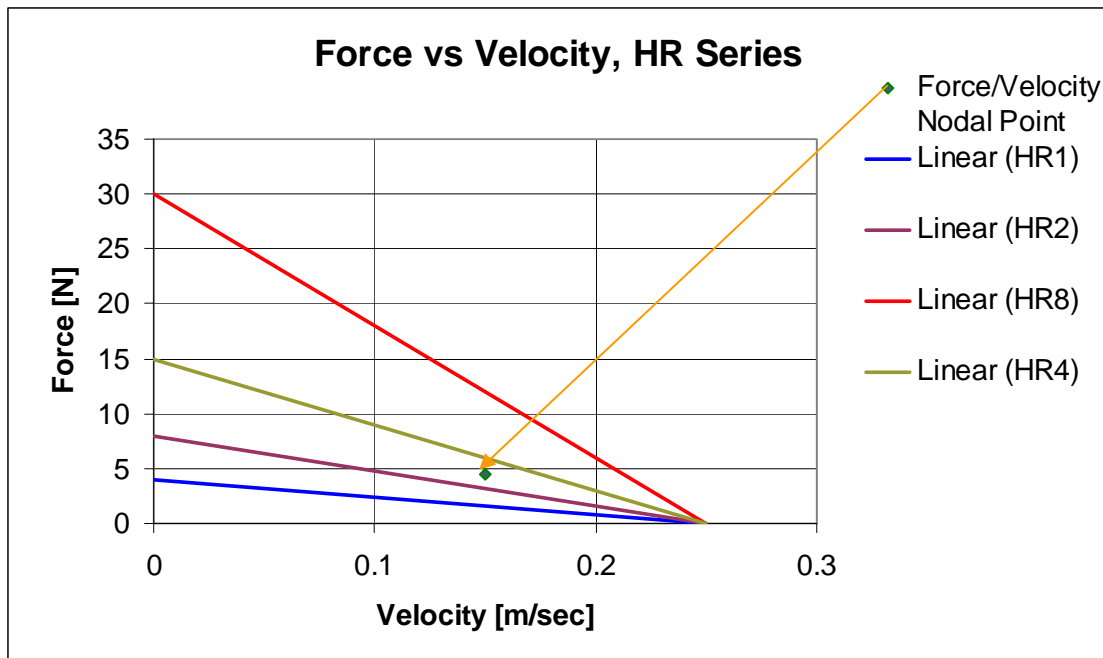



Settling Time

The achievable settling time is mainly dictated by the damping of the motor and the natural frequency of the system. A typical number of three cycles is required for the motor damping to damp the system vibration along the motion axis, so the settling time will be roughly according to the following formula:

$$T_s = 3/Fr$$

Where Fr is the natural frequency of the system, and is calculated according to the following formula:

$$Fr = \frac{1}{2\pi} \sqrt{\frac{K}{m}}$$

Where:

K - stiffness of the motor in Newton/meter

m - mass of the moving part in Kg

If the desired natural frequency is higher than the one calculated for a given configuration, adding another motor in parallel or in tandem will increase the system's natural frequency due to the increased stiffness. The combined stiffness of several motors is the algebraic sum of the stiffness of the individual motors. One should recalculate the natural frequency using the combined stiffness of the motors. It is worthwhile to note that the effective motor stiffness increases under close loop operation.

Driving vertically with a motor that actuates based on friction requires specific consideration to the static load, separate from the dynamic force. As a rule of thumb, each 4.4N element can drive 120 grams vertically. Beyond this a counter balance should be considered. This can be in the form of a spring, a continuous force gas spring, or opposing weight.



Mechanical Assembly Procedures and Safeguards

WARNING: NEVER OPERATE THE MOTOR UN-LOADED, WITHOUT PRELOAD AGAINST A NANOMOTION DRIVE STRIP.

Proper mounting procedures are described in each motor manual, with preload being set by a shim (provided with ST, HR1 & HR2 motors), or a cam (internal to the HR4 & HR8 motors). The motor should be mounted perpendicular to travel, with the arrows on the motor label indicating the direction of travel.

In applications utilizing the HR4 & HR8 motors, it is important to avoid compressing the motor against the ceramic strip, prior to engaging the cams. This additional force will result in a higher than expected preload. If there is a concern about controlling the force during mounting it is acceptable to use a shim, when the fingertips are in a retracted position, up to 15 μ m thickness. This will assure that the motor elements are not 'over compressed' against the drive strip.

Always make sure the mechanical travel does not permit the motor fingers to become disengaged from the ceramic drive strip. The fingertips should remain in a compressed state at all times.

Most Nanomotion provided drive strips have a 3M acrylic tape bonded to them. Nanomotion can provide the specification on the tape for those customers who require it. When applying the ceramic with the tape, make sure there are no air bubbles and the ceramic strip is applied to a clean surface. After adhering the drive strip, secure it with two drops of epoxy, per the instructions in the manual, to prevent any motion in shear.



Electrical Interface

Nanomotion's motors run at resonant frequency and are sensitive to the capacitance of the electrical circuit. Changing cable lengths will affect the total capacitance. There are guidelines provided in Nanomotion's catalog and manuals as to the acceptable cable lengths.

In addition to the cable length from the motor to the amplifier, caution should be used if third party cable is used. Nanomotion provides motors with specific low capacitance cable at:

Standard motors: 64pF/foot

Vacuum motors: 13pF/foot

If the capacitance of the electrical circuit is too high, the full performance of the motor will not be realized. Nanomotion can provide guidelines for testing capacitance.

Motor Connection

- Connect a ground wire from the motor to the amplifier chassis screw.
- Connect the amplifier's analog ground to the controller's analog ground (even when using differential command).
- Tie un-used +Vin or -Vin amplifier inputs to amplifier's analog ground.
- For AB1A, AB2 and AB4: need the controller to generate an active low enable signal (ACTIVE = short to ground.) AB5 supports both active high and active low.

Conditioning (burn-in)

- Must condition motor before tuning and any time after a motor has been removed and re-mounted
- Limit command to 5V and use "Abort on Position Error" at the controller to protect the motor during initial integration and conditioning.
- Conditioning cycle: 4 hours minimum at 50 mm/sec, 50% duty cycle max, running end-to-end in an open loop condition. The CCS drive strip should condition for ~18 to 20 hours
- Condition at ambient – never in vacuum
- At the end, wipe the ceramic with isopropyl alcohol without retracting the fingers

Tuning

Nanomotion offers a variety of amplifiers that provide a wide range of performance benefits. From a tuning perspective, there are 2 main differences between the amplifiers that should be understood:

1. The AB5 amplifier, which linearizes the voltage to velocity profile and can work with any servo controller.
2. The AB1A, AB2, and AB4 which has a dead-band and should use a simple firmware algorithm to facilitate good performance

The Voltage to Velocity profile is represented in a simple graph as shown.

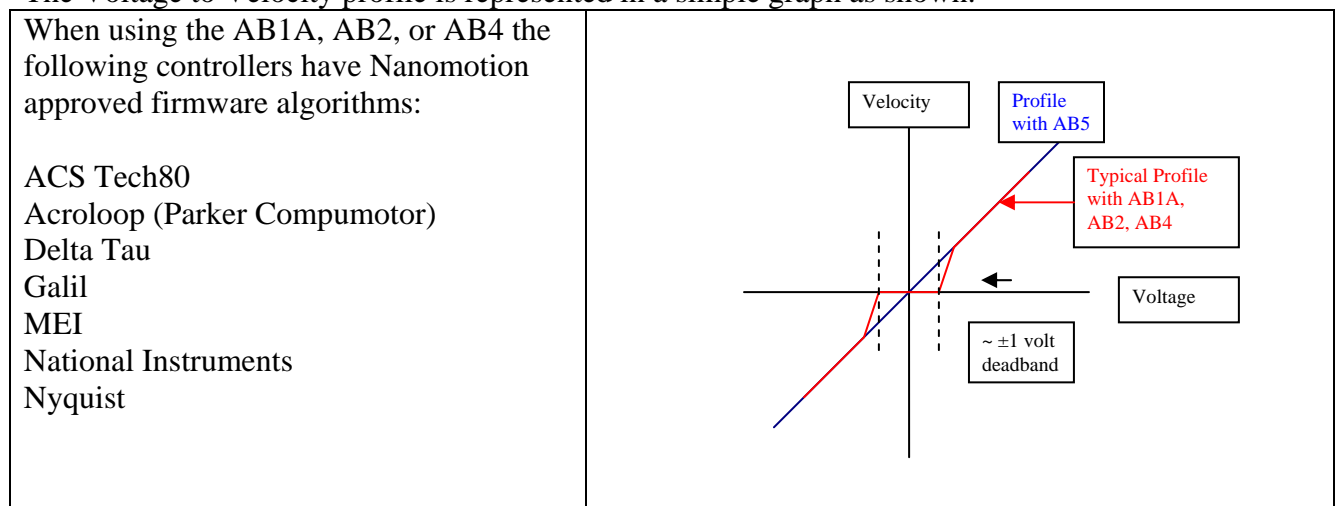

The use of the deadband algorithm requires that command threshold be established, which is the point when motion starts. This point can typically range between .8 and 1.5 volts. Depending on the specific drive, motor and mechanical structure, the deadband can be slightly higher or lower.

Once the deadband value is identified, establish the command setting at 60% to 70% of this number. So if the deadband measured ± 1 volt, establish .6 to .7 volts as the deadband. This number may not necessarily be the same in both directions.

The AB5 amplifier utilizes typical tuning values, similar to that of a brushless dc motor. There is no need for any special algorithm and tuning can start with Kp (leaving Ki & Kd at zero). Kp will provide stiffness of the system, Kd will provide damping and Ki will support the ability to achieve final positioning.

Once the tuning parameters have yielded the desired performance vary each parameter by +/- 20% and re-confirm performance. This will ensure that the parameters are robust and capable of supporting any small changes in the mechanical structure.



Operation

- Do not exceed the Envelop of Performance (published in motor manuals and catalogs) when running motor.
- If there are questions regarding the specific curve the system is operating on, it is prudent to limit the voltage to 5V from the controller or reduce the duty cycle to 50% until it is determined what is required for the application. For operation in vacuum, a limit of 30% duty cycle is prudent.
- When using the AB5 amplifier, it is recommended to disable the amplifier after reaching the desired position. This will reduce the operating temperature and increase the life of the system. For all vacuum and UHV motors it is particularly important to utilize this feature.

General Safety Precautions

- Do not remove the cover of the motor. High voltage inside!
- Do not immerse the motor in any solvent or cleaning agent.
- Use only a dry, clean, lint free cloth to wipe the motor.